

QFP-CW31FG-10DC

40Gbps QSFP+ Transceiver, Single Mode, 10km Reach

Product Features

- 4 CWDM lanes MUX/DEMUX design
- Transmission data rate up to 11.3Gbps per channel
- SMF LC duplex connector
- Hot Pluggable QSFP+ form factor
- 1310nm DFB laser and PIN photodiode ,Up to 10km transmission
- Compatible with RoHS
- Single +3.3V power supply
- Real Time Digital Diagnostic Monitoring
- Operating case temperature: 0 to +70°C

Applications

- 40GBASE-LR4 Ethernet
- Switch, router and HBAs
- Data Center Interconnect
- Infiniband QDR
- 40G Campus Link



Description

The QSFP+ LR4 transceivers are high performance, cost effective modules supporting data rate of 40Gbps and 10km transmission distance with SMF.

The transceiver consists of three sections: 4 inputs channels (ch) of 10Gb/s electrical data to 4 CWDM optical signals, and multiplexes them into a single channel for 40Gb/s optical transmission; on the receiver side, the module optically de-multiplexes a 40Gb/s input into 4 CWDM channels signals, and converts them to 4 channel output electrical data; and MCU control unit. All modules satisfy class I laser safety requirements.

The transceivers are compatible with 40GBASE-LR4 of IEEE802.3ba standard and SFF-8436 specification.

Absolute Maximum Ratings

Parameter	Symbol	Min	Max	Unit
Supply Voltage	V _{cc}	-0.5	4.5	V
Storage Temperature	T _s	-40	+85	°C
Operating Humidity	-	5	85	%

Recommended Operating Conditions

Parameter	Symbol	Min	Typical	Max	Unit
Operating Case Temperature	T _c	0		+70	°C
Power Supply Voltage	V _{cc}	3.135	3.30	3.465	V
Power Dissipation	P _m			3.5	W
Data Rate			10.3125	11.3	Gbps

Optical and Electrical Characteristics

Parameter	Symbol	Min	Typical	Max	Unit	Notes
Transmitter						
Centre Wavelength	L0	1264.5	1271	1277.5	nm	
	L1	1284.5	1291	1297.5	nm	
	L2	1304.5	1311	1317.5	nm	
	L3	1324.5	1331	1337.5	nm	
-20dB Spectral Width	$\Delta\lambda$			1	nm	
Side-mode Suppression Ratio	SMSR	30	-		dB	
Total Average Launch Power	P _T			8.3	dBm	
Average launch power, each lane	P _{out}	-7		2.3	dBm	
Extinction Ratio	ER	3.5			dB	
Average launch power of OFF transmitter, each lane	P _{off}			-30	dBm	
Relative Intensity Noise	R _{in}			-128	dB/Hz	12dB reflection
Transmitter Reflectance	R _T			-12	dB	
Data Input Swing Differential	V _{IN}	190		700	mV	
Input Differential Impedance	Z _{IN}	90	100	110	Ω	

Receiver						
Centre Wavelength	L0	1264.5	1271	1277.5	nm	
	L1	1284.5	1291	1297.5	nm	
	L2	1304.5	1311	1317.5	nm	
	L3	1324.5	1331	1337.5	nm	
Damage threshold	THd	3.3			dBm	
Average power at receiver input,each lane		-13.7		2.3	dBm	
LOS De-Assert	LOS _D			-15	dBm	
LOS Assert	LOS _A	-30			dBm	
LOS Hysteresis		0.5			dB	
Receive Electrical 3 dB upper Cutoff Frequency, each Lane	F _C			11.3	GHz	

Digital Diagnostic Memory Map

The transceivers provide serial ID memory contents and diagnostic information about the present operating conditions by the 2-wire serial interface (SCL, SDA).

The digital diagnostic memory map specific data field defines as following.

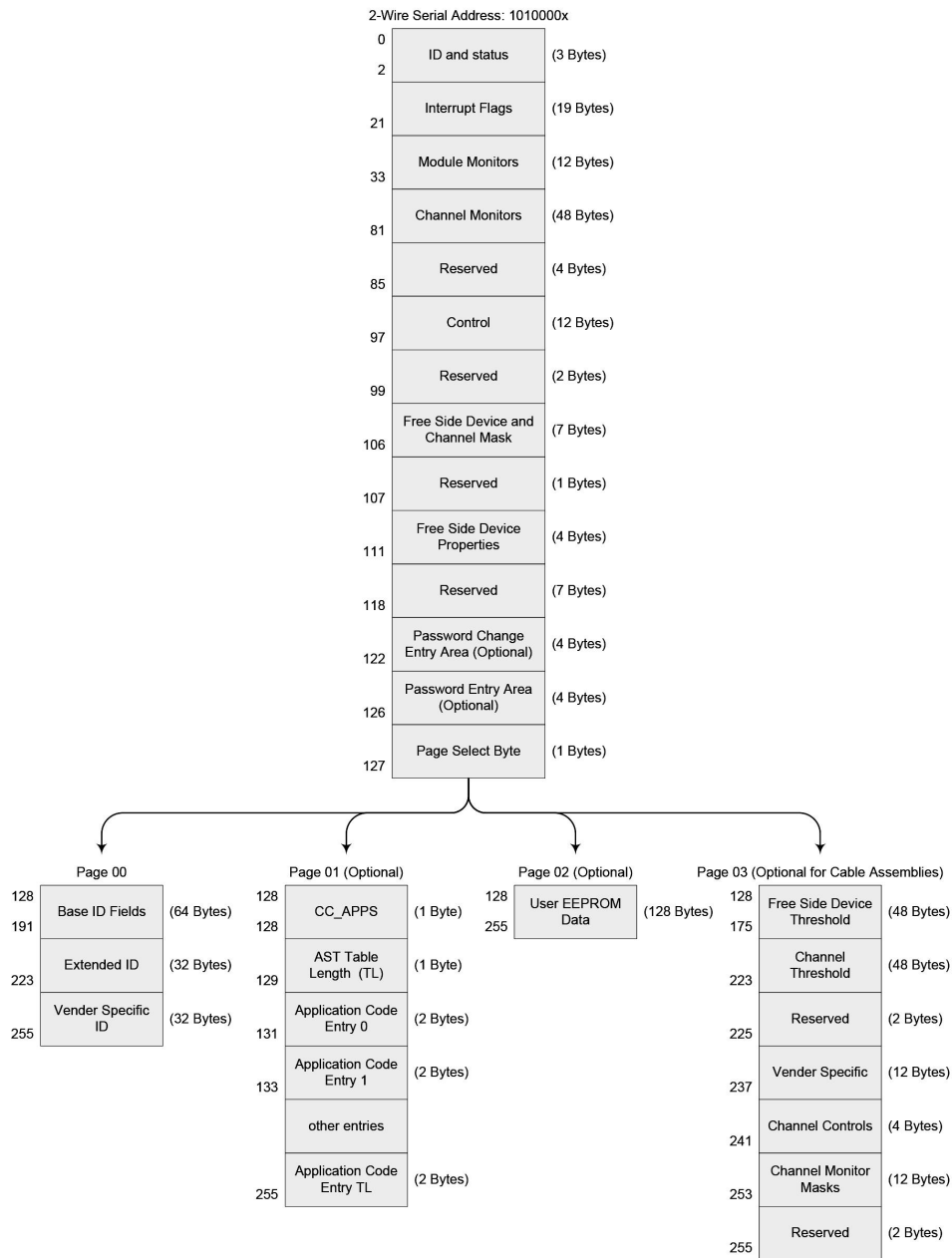

Pin Descriptions

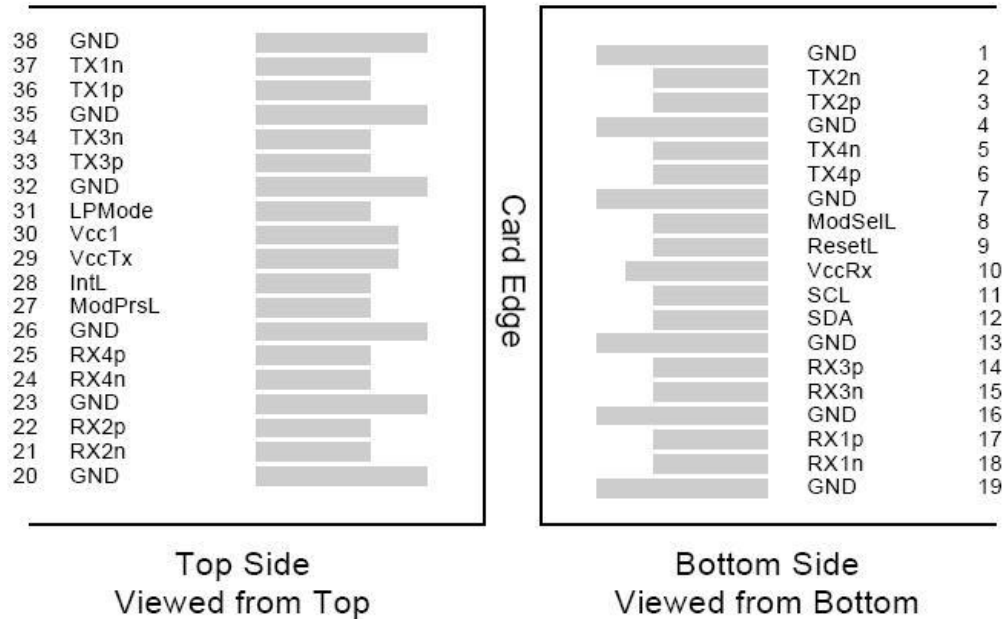

PIN	Logic	Symbol	Name/Description	Note
1		GND	Ground	1
2	CML-I	Tx2n	Transmitter Inverted Data Input	
3	CML-I	Tx2p	Transmitter Non-Inverted Data output	
4		GND	Ground	1
5	CML-I	Tx4n	Transmitter Inverted Data Input	
6	CML-I	Tx4p	Transmitter Non-Inverted Data output	
7		GND	Ground	1
8	LVTLL-I	ModSelL	Module Select	
9	LVTLL-I	ResetL	Module Reset	
10		VccRx	+ 3.3V Power Supply Receiver	2
11	LVC MOS-I/O	SCL	2-Wire Serial Interface Clock	
12	LVC MOS-I/O	SDA	2-Wire Serial Interface Data	
13		GND	Ground	
14	CML-O	Rx3p	Receiver Non-Inverted Data Output	
15	CML-O	Rx3n	Receiver Inverted Data Output	
16		GND	Ground	1
17	CML-O	Rx1p	Receiver Non-Inverted Data Output	

18	CML-O	Rx1n	Receiver Inverted Data Output	
19		GND	Ground	1
20		GND	Ground	1
21	CML-O	Rx2n	Receiver Inverted Data Output	
22	CML-O	Rx2p	Receiver Non-Inverted Data Output	
23		GND	Ground	1
24	CML-O	Rx4n	Receiver Inverted Data Output	1
25	CML-O	Rx4p	Receiver Non-Inverted Data Output	
26		GND	Ground	1
27	LVTTTL-O	ModPrsL	Module Present	
28	LVTTTL-O	IntL	Interrupt	
29		VccTx	+3.3 V Power Supply transmitter	2
30		Vcc1	+3.3 V Power Supply	2
31	LVTTTL-I	LPMODE	Low Power Mode	
32		GND	Ground	1
33	CML-I	Tx3p	Transmitter Non-Inverted Data Input	
34	CML-I	Tx3n	Transmitter Inverted Data Output	
35		GND	Ground	1
36	CML-I	Tx1p	Transmitter Non-Inverted Data Input	
37	CML-I	Tx1n	Transmitter Inverted Data Output	
38		GND	Ground	1

Notes:

1. GND is the symbol for signal and supply (power) common for QSFP modules. All are common within the QSFP module and all module voltages are referenced to this potential unless otherwise noted. Connect these directly to the host board signal common ground plane.

2. VccRx, Vcc1 and VccTx are the receiver and transmitter power suppliers and shall be applied concurrently. Recommended host board power supply filtering is shown below. Vcc Rx, Vcc1 and Vcc Tx may be internally connected within the QSFP transceiver module in any combination. The connector pins are each rated for a maximum current of 500mA.

Mechanical Dimensions

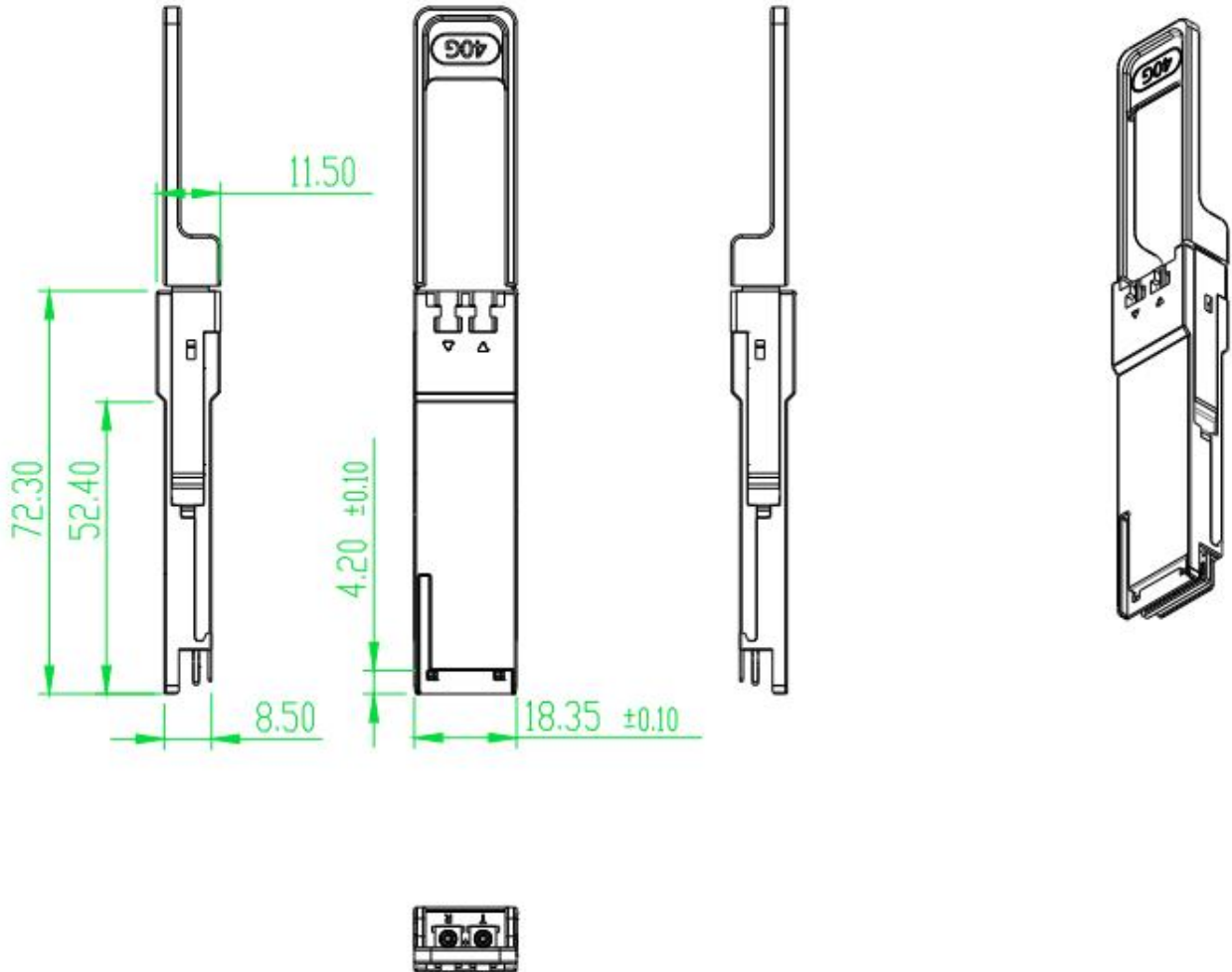

Ordering information

Part Number	Product Description
QFP-CW31FG-10DC	4 CWDM channels, 40Gbps, LC, 10km, 0°C~+70°C, with DDM

For More Information

Tel:+86-755-23301665

E-mail : sales@fibertoptech.com

Web: <http://www.fibertoptech.com>